



DF612 - Silverlink 600 Electric Counter-top Twin Tank Fryer - 2 Baskets - W 600 mm - 2 x 6.0 kW

The Silverlink 600 Electric Twin Tank Counter Top Fryer not only provides greater versatility, but also increased power capable of delivering 52kg of chips per hour.

- ✓ Two independently operated fryer tanks for greater versatility, increased power delivers 52kg of chips per hour
- ✓ Front mounted controls for safety
- ✓ Hinged elements to give easy access during cleaning
- ✓ Cool zone collects cooking debris - gives cleaner cooking results and saves money by prolonging the life of the oil
- ✓ Thermostatically controlled to give accurate cooking temperatures throughout cooking. Fail-safe top temperature cut out ensures safe operation.
- ✓ Fully moulded 304 stainless steel tank and heavy duty nickel plated baskets for the most demanding of operations
- ✓ Front drain off tap for easy removal of cooking oil

Specifications

Summary

| | |
|-----------------------------|-----------------------------------|
| Range Name | Silverlink 600 |
| Power Type | Electric |
| Unit Type | Counter-top |
| Available in UK Only | No |
| UK Warranty | 2 Years Parts and Labour Warranty |
| Export Warranty | Contact your local dealer |
| GTIN Code | 5056105104643 |

Power and Performance

| | |
|-----------------------------|------------|
| Total Power kW | 2 x 6.0 |
| Temperature Range °C | 130 - 190 |
| IP Rating | IP33 |
| Temperature Control | Mechanical |

Key Specifications

| | |
|---------------------------|---------------|
| Capacity Litres | 2 x 9.0 |
| Number of Baskets | 2 |
| Number of Tanks | 2 |
| Gravity Filtration | No |
| Pumped Filtration | No |
| Drain Location | Front-mounted |

Weights and Dimensions

| | |
|----------------------------------|-----|
| Unit Height (External) mm | 330 |
| Unit Width (External) mm | 600 |
| Unit Depth (External) mm | 632 |
| Net Weight Kg | 25 |

Supply Connections

| | |
|---------------------------------------|------------------------------------|
| Requires Installation | Yes |
| Requires Electrical Supply | Yes |
| UK 3 Pin Plug | No |
| Requires Hardwiring | Yes |
| Electrical Supply Rating Watts | 2 x 6,000 |
| Single Phase Amps | 2 x 26.0 |
| Single Phase Voltage | 230 |
| Three Phase Amps | L1=2 x 13.0 ; L2=2 x 13.0 ; L3=N/A |
| Three Phase Voltage | 400 |

Shipping

| | |
|-------------------------|------|
| Packed Weight Kg | 31 |
| Packed Height cm | 49.5 |
| Packed Width cm | 70 |
| Packed Depth cm | 70 |

Available Accessories

| | |
|-------------|--|
| BA96 | BASKET SPUN DFSMALL |
| CC6 | Silverlink 600 Free-standing Ambient Open-Top Pedestal with Doors - W 600 mm |
| CN6 | Silverlink 600 Free-standing Ambient Open-Top Pedestal without Doors - W 600 mm |
| HC6 | Silverlink 600 Free-standing Heated Open-Top Pedestal with Doors - W 600 mm - 0.5 kW |

Available Accessories

- HCL6** Silverlink 600 Free-standing Heated Pedestal with Legs and Doors - W 600 mm - 0.5 kW
- SLS6** Silverlink 600 Free-standing Floor Stand - for units W 600 mm

Technical Picture

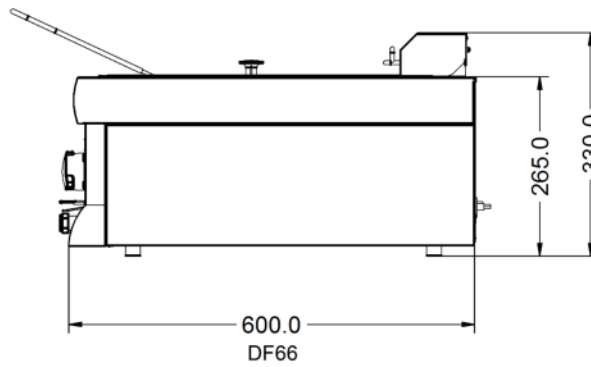
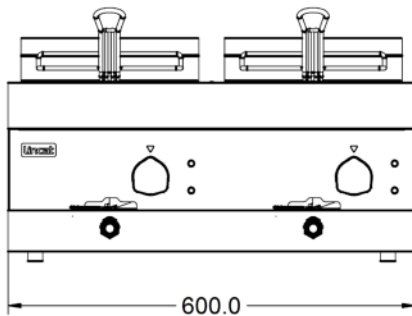
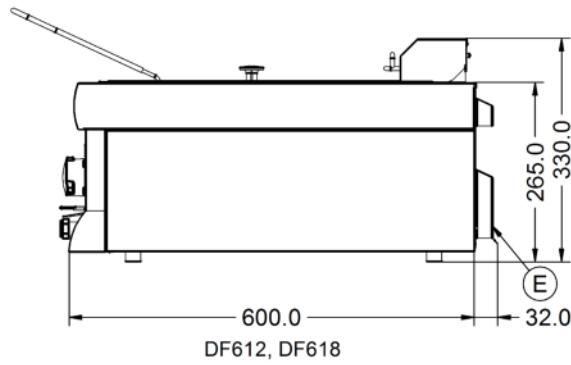
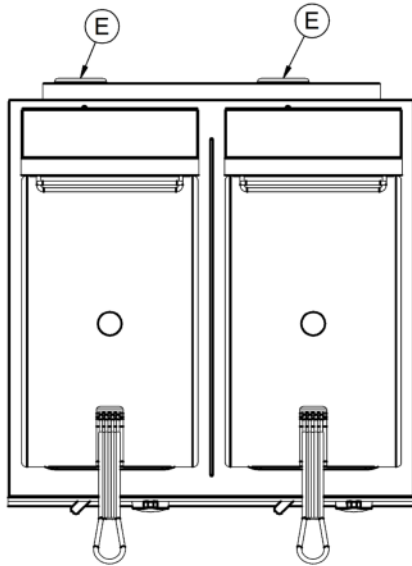



Lincat Limited

Whisby Road,
Lincoln, LN6 3QZ,
United Kingdom

Company No: 2175448

A member company of



Customer Care

Tel: +44 1522 875500
Email: care@lincat.co.uk

Export Customers

Tel: +44 1522 503250
Email: export@lincat.co.uk

Opening Hours

Monday – Friday:
8.30am – 5pm