



## OE8211 - Lincat Opus 800 Electric Counter-top Clam Griddle - Flat Upper Plate - W 400 mm - 8.6 kW

Cook flavoursome and succulent food up to three times faster than with a traditional griddle with the Opus 800 Clam Griddle with a flat upper plate.

- ✔ Heat from above and below locks in flavour and reduces shrinkage of meat
- ✔ Digital timer on clam plate ensures repeatable results
- ✔ Cook food up to three times as quickly as a standard griddle
- ✔ Precise thermostatic control for consistent results and economical operation

### Specifications

#### Summary

<b>Brand</b>	Lincat
<b>Range</b>	Opus 800
<b>Power Type</b>	Electric
<b>Unit Type</b>	Counter-top
<b>Available in UK Only</b>	No
<b>UK Warranty</b>	2 Years Parts and Labour Warranty
<b>Export Warranty</b>	Contact your local dealer
<b>GTIN</b>	5056105102595

#### Power and Performance

<b>Total Power kW</b>	8.6
<b>Temperature Range °C</b>	50-250
<b>IP Rating</b>	IP24
<b>Cooking Area (Width x Depth) mm</b>	366 x 525
<b>Temperature Control</b>	Mechanical

#### Key Specifications

<b>Number of Heat Zones</b>	1
<b>Top Grill Plate Surface Type</b>	Smooth
<b>Grill Plate Surface Type</b>	Smooth
<b>Grill Plate Material</b>	Aluminium

#### Capacity

<b>Product Output per Hour</b>	160 x 113g burgers [4oz] burgers [frozen]
--------------------------------	---

#### Weights and Dimensions

<b>Unit Height (External) mm</b>	542
<b>Unit Width (External) mm</b>	400
<b>Unit Depth (External) mm</b>	800
<b>Net Weight Kg</b>	79.5

#### Supply Connections

<b>Requires Installation</b>	Yes
<b>Requires Electrical Supply</b>	Yes
<b>UK 3 Pin Plug</b>	No
<b>Requires Hardwiring</b>	Yes
<b>Electrical Supply Rating Watts</b>	8,600
<b>Three Phase Amps</b>	L1=14.0; L2=14.0; L3=9.0
<b>Three Phase Voltage</b>	400

#### Shipping

<b>Packed Weight Kg</b>	94.5
<b>Packed Height cm</b>	64
<b>Packed Width cm</b>	85
<b>Packed Depth cm</b>	45

### Available Accessories

<b>OA8921</b>	Lincat Opus 800 Free-standing Floor Stand with Legs - for units W 400 mm
<b>OA8960</b>	3 POSITION HEIGHT ADJUSTER 10-20-30 - OPUS 800
<b>OA8971</b>	Lincat Opus 800 Free-standing Pedestal with Doors and Legs - for units W 400 mm
<b>TFS01</b>	Teflon Sheet for Clam Griddles [392mm x 500mm]

Technical Picture

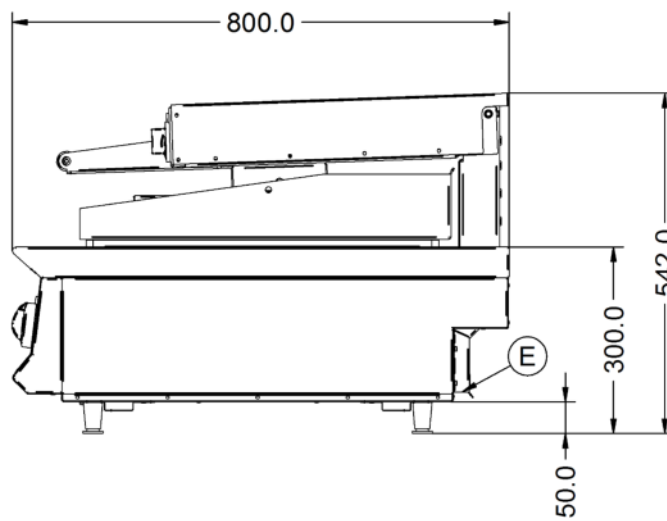
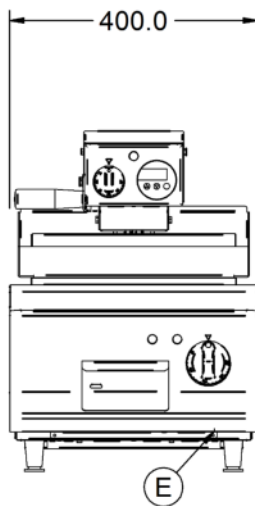
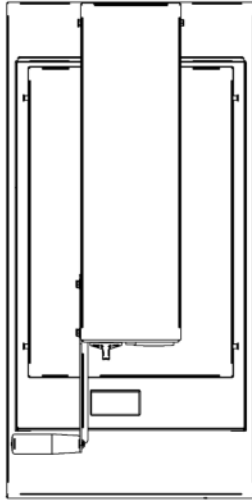

**Lincat Limited**

Whisby Road,  
Lincoln, LN6 3QZ,  
United Kingdom

**Company No:** 2175448

A member company of



**Customer Care**

**Tel:** +44 1522 875500  
**Email:** care@lincat.co.uk

**Export Customers**

**Tel:** +44 1522 875536  
**Email:** export@lincat.co.uk

**Opening Hours**

**Monday – Friday:**  
8.30am – 5pm