



GG1 - Lincat Lynx 400 Electric Counter-top Heavy Duty Contact Grill - Smooth Upper & Lower Plates - W 395 mm - 3.0 kW

Designed to seal in the juices, the quick-heating 3kW Lynx 400 Contact Grill produces mouthwatering results every time, whether you're making toasted sandwiches or grilling succulent meats.

- ✔ Heavy duty, higher powered griddle
- ✔ Smooth plates top and bottom for an even colour
- ✔ Higher capacity for increased output in busy periods
- ✔ Ideal for front of house use
- ✔ Great for sealing in juices and flavour for succulent results - and minimal shrinkage
- ✔ Cast aluminium plates give an even heat distribution
- ✔ Non stick coated plates for easy cleaning
- ✔ Plug and play for an easy installation

Specifications

Summary

Brand	Lincat
Range	Lynx 400
Power Type	Electric
Unit Type	Counter-top
Available in UK Only	No
UK Warranty	2 Years Parts and Labour Warranty
Export Warranty	Contact your local dealer
GTIN	5056105101161

Power and Performance

Total Power kW	3.00
IP Rating	IP23
Cooking Area (Width x Depth) mm	358 x 258
Temperature Control	Mechanical

Key Specifications

Top Grill Plate Surface Type	Smooth
Grill Plate Surface Type	Smooth
Grill Plate Material	Aluminium

Weights and Dimensions

Unit Height (External) mm	276
Unit Width (External) mm	395
Unit Depth (External) mm	356
Net Weight Kg	23.1

Supply Connections

Requires Installation	No
Requires Electrical Supply	Yes
UK 3 Pin Plug	Yes
Requires Hardwiring	No
Electrical Supply Rating Watts	3,000
Single Phase Amps	13.0
Single Phase Voltage	230

Shipping

Packed Weight Kg	25.4
Packed Height cm	42
Packed Width cm	48.5
Packed Depth cm	48.5

Available Accessories

OS1	OMELETTE SPACER - FOR GG1
SS1	SANDWICH SPACER - FOR GG1

Technical Picture

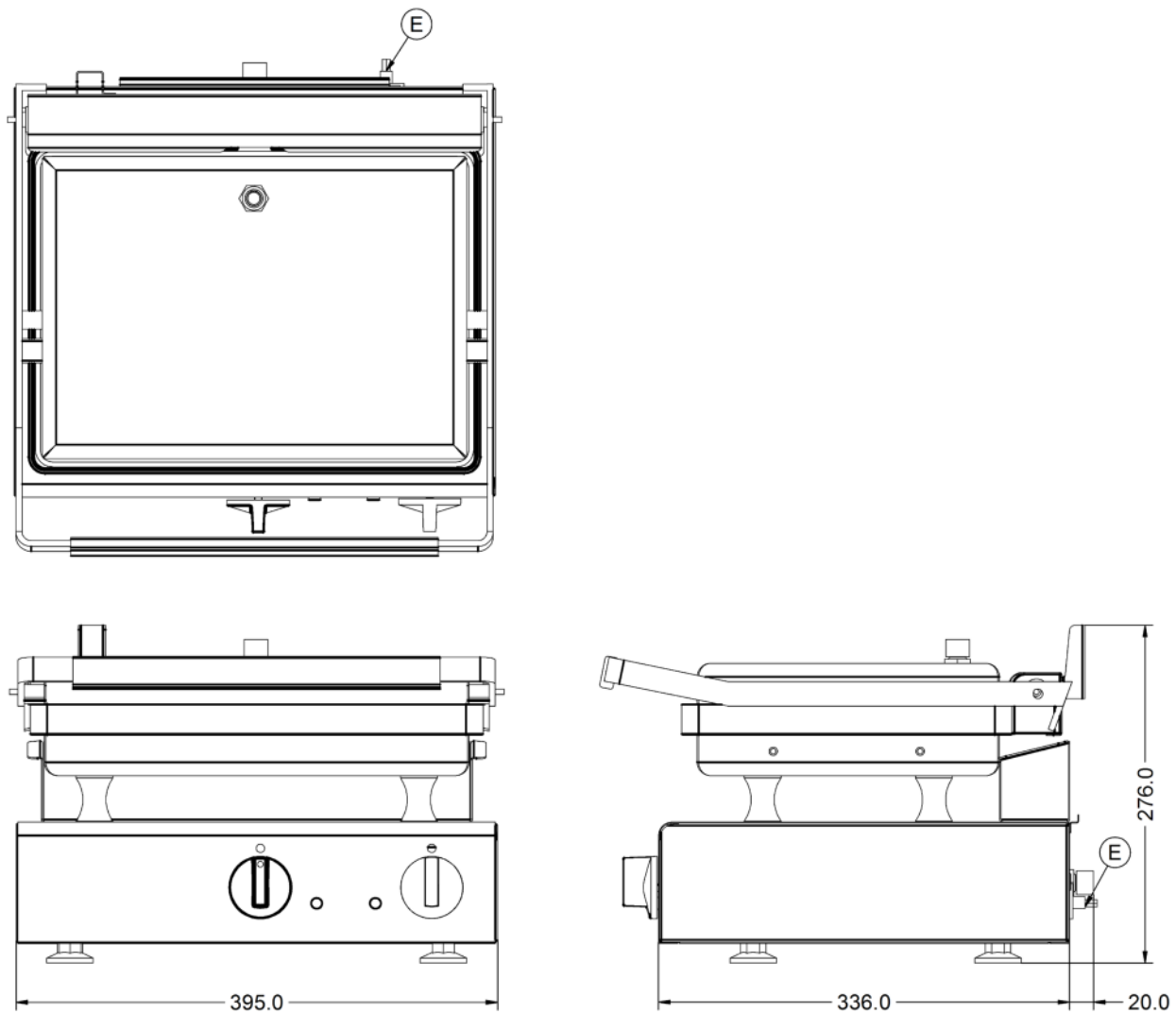

Lincat Limited

Whisby Road,
Lincoln, LN6 3QZ,
United Kingdom

Company No: 2175448

A member company of



Customer Care

Tel: +44 1522 875500
Email: care@lincat.co.uk

Export Customers

Tel: +44 1522 875536
Email: export@lincat.co.uk

Opening Hours

Monday – Friday:
8.30am – 5pm